



## >> SDS-PLUS HAMMERBOHRER „F4“, 2 SCHNEIDEN

### Einsatzbereich:

Der SDS-plus Hammerbohrer **F4** mit patentiertem 4-fach-Stufenprofil und patentierter Hartmetallplatte. Geringer Verschleiß, sehr hohe Standzeit. Hochleistungsbohrer zum Hammerbohren in Beton, Naturstein und Mauerwerk.

|                                  |                                       |                                        |
|----------------------------------|---------------------------------------|----------------------------------------|
| <b>LEISTUNGSSTARK</b>            | <b>ROBUST</b>                         | <b>EXAKT</b>                           |
| durch modernste Vakuumbestimmung | durch hochbelastbare Hartmetallspitze | durch exzellente Zentriereigenschaften |

## SDS-PLUS HAMMER DRILLS “F4”, 2 CUTTING EDGES

### Range of application:

The SDS-plus hammer drill **F4** with its patented 4X stepped profile and patented tip. Low wear, very long service life. High efficiency drill for heavy-duty drilling in concrete, natural stone and brickwork.

|                                             |                                              |                                          |
|---------------------------------------------|----------------------------------------------|------------------------------------------|
| <b>EFFICIENT</b>                            | <b>ROBUST</b>                                | <b>PRECISE</b>                           |
| thanks to state-of-the-art vacuum hardening | thanks to high-strength tungsten-carbide tip | thanks to excellent centering properties |

## PERFORATORI SDS-PLUS „F4“, 2 TAGLIENTI

### Impiego:

Le punte SDS-plus **F4** a 4 taglianti a gradino brevettati e con placchetta brevettata. Minima usura, elevata durata. Punte ad elevata produttività per lavorazione di cemento, pietre e muro.

|                                          |                                                     |                             |
|------------------------------------------|-----------------------------------------------------|-----------------------------|
| <b>RENDIMENTO</b>                        | <b>ROBUSTA</b>                                      | <b>PRECISE</b>              |
| grazie al trattamento termico sottovuoto | grazie alla particolare affilatura della placchetta | grazie a centatura perfetta |

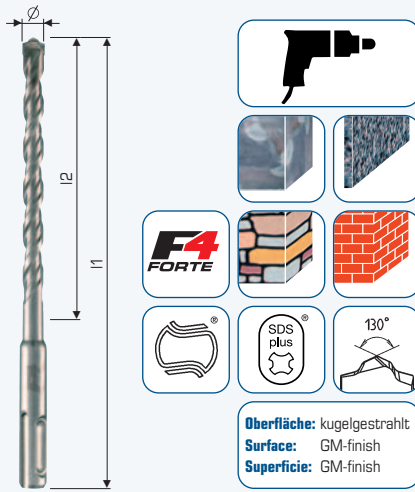

► Länge | Length | Lunghezza: 110/50 mm

| Ø<br>mm | L1<br>mm | L2<br>mm | Z | Code 807<br>Art.-Nr. | Inh.<br>Cont. | €/Stk.<br>€/pc. | Code 768<br>Art.-Nr. | Inh.<br>Cont. | €/Stk.<br>€/pc. |
|---------|----------|----------|---|----------------------|---------------|-----------------|----------------------|---------------|-----------------|
| 4,00    | 110      | 50       | 2 | 00 807004001 00      | 1 10          | 5,01            | 00 768004001 00      | 10            | 4,35            |
| 5,00    | 110      | 50       | 2 | 00 807005001 00      | 1 10          | 4,01            | 00 768005001 00      | 10            | 3,38            |
| 5,50    | 110      | 50       | 2 | 00 807005501 00      | 1 10          | 4,17            | 00 768005501 00      | 10            | 3,52            |
| 6,00    | 110      | 50       | 2 | 00 807006001 00      | 1 10          | 3,95            | 00 768006001 00      | 10            | 3,31            |
| 6,50    | 110      | 50       | 2 | 00 807006501 00      | 1 10          | 4,83            | 00 768006501 00      | 10            | 4,17            |
| 7,00    | 110      | 50       | 2 | 00 807007001 00      | 1 10          | 4,83            | 00 768007001 00      | 10            | 4,17            |
| 8,00    | 110      | 50       | 2 | 00 807008001 00      | 1 10          | 4,83            | 00 768008001 00      | 10            | 4,17            |
| 10,00   | 110      | 50       | 2 | 00 807010001 00      | 1 10          | 5,79            | 00 768010001 00      | 10            | 5,13            |

► Länge | Length | Lunghezza: 160/100 mm

| Ø<br>mm | L1<br>mm | L2<br>mm | Z | Code 817<br>Art.-Nr. | Inh.<br>Cont. | €/Stk.<br>€/pc. | Code 769<br>Art.-Nr. | Inh.<br>Cont. | €/Stk.<br>€/pc. |
|---------|----------|----------|---|----------------------|---------------|-----------------|----------------------|---------------|-----------------|
| 4,00    | 160      | 100      | 2 | 00 817004001 00      | 1 10          | 5,33            | 00 769004001 00      | 10            | 4,63            |
| 5,00    | 160      | 100      | 2 | 00 817005001 00      | 1 10          | 4,83            | 00 769005001 00      | 10            | 4,17            |
| 5,50    | 160      | 100      | 2 | 00 817005501 00      | 1 10          | 4,83            | 00 769005501 00      | 10            | 4,17            |
| 6,00    | 160      | 100      | 2 | 00 817006001 00      | 1 10          | 4,63            | 00 769006001 00      | 10            | 3,95            |
| 6,50    | 160      | 100      | 2 | 00 817006501 00      | 1 10          | 5,59            | 00 769006501 00      | 10            | 4,95            |
| 7,00    | 160      | 100      | 2 | 00 817007001 00      | 1 10          | 5,79            | 00 769007001 00      | 10            | 5,13            |
| 8,00    | 160      | 100      | 2 | 00 817008001 00      | 1 10          | 5,21            | 00 769008001 00      | 10            | 4,55            |
| 9,00    | 160      | 100      | 2 | 00 817009001 00      | 1 10          | 6,38            | 00 769009001 00      | 10            | 5,71            |
| 9,50    | 160      | 100      | 2 | 00 817009501 00      | 1 10          | 6,38            | 00 769009501 00      | 10            | 5,71            |
| 10,00   | 160      | 100      | 2 | 00 817010001 00      | 1 10          | 5,93            | 00 769010001 00      | 10            | 5,27            |
| 11,00   | 160      | 100      | 2 | 00 817011001 00      | 1 10          | 7,35            | 00 769011001 00      | 5             | 6,70            |
| 12,00   | 160      | 100      | 2 | 00 817012001 00      | 1 10          | 7,35            | 00 769012001 00      | 5             | 6,70            |
| 13,00   | 160      | 100      | 2 | 00 817013001 00      | 1 10          | 9,50            | 00 769013001 00      | 5             | 8,84            |
| 14,00   | 160      | 100      | 2 | 00 817014001 00      | 1 10          | 10,02           | 00 769014001 00      | 5             | 9,36            |
| 15,00   | 160      | 100      | 2 | 00 817015001 00      | 1 10          | 11,97           | 00 769015001 00      | 5             | 11,32           |
| 16,00   | 160      | 100      | 2 | 00 817016001 00      | 1 10          | 13,91           | 00 769016001 00      | 5             | 13,27           |

Fortsetzung auf Seite VIII/5 | Continued on page VIII/5 | Segue a pagina VIII/5



**>> SDS-PLUS HAMMERBOHRER  
 „F4“, 2 SCHNEIDEN**
**SDS-PLUS HAMMER DRILLS  
 “F4”, 2 CUTTING EDGES**
**PERFORATORI SDS-PLUS  
 „F4“, 2 TAGLIENTI**

Fortsetzung von Seite VIII/4 | Continued from page VIII/4 | Segue da pagina VIII/4

| ▶ Länge   Length   Lunghezza: 210/150 mm |          |          |   | Plastiktasche   Plastic wallet<br>Confezione busta |               |                  |                      | Gewerbepack   Industrial packing<br>Confezione industriale |                  |  |
|------------------------------------------|----------|----------|---|----------------------------------------------------|---------------|------------------|----------------------|------------------------------------------------------------|------------------|--|
| Ø<br>mm                                  | l1<br>mm | l2<br>mm | Z | Code 827<br>Art.-Nr.                               | Inh.<br>Cont. | € /Stk.<br>€/pc. | Code 770<br>Art.-Nr. | Inh.<br>Cont.                                              | € /Stk.<br>€/pc. |  |
| 5,00                                     | 210      | 150      | 2 | 00 827005001 00                                    | 1 8           | 6,49             | 00 770005001 00      | 10                                                         | 5,86             |  |
| 5,50                                     | 210      | 150      | 2 | 00 827005501 00                                    | 1 8           | 6,49             | 00 770005501 00      | 10                                                         | 5,86             |  |
| 6,00                                     | 210      | 150      | 2 | 00 827006001 00                                    | 1 8           | 6,49             | 00 770006001 00      | 10                                                         | 5,86             |  |
| 6,50                                     | 210      | 150      | 2 | 00 827006501 00                                    | 1 8           | 6,49             | 00 770006501 00      | 10                                                         | 5,86             |  |
| 7,00                                     | 210      | 150      | 2 | 00 827007001 00                                    | 1 8           | 6,43             | 00 770007001 00      | 10                                                         | 5,79             |  |
| 8,00                                     | 210      | 150      | 2 | 00 827008001 00                                    | 1 8           | 6,43             | 00 770008001 00      | 10                                                         | 5,79             |  |
| 9,00                                     | 210      | 150      | 2 | 00 827009001 00                                    | 1 8           | 7,83             | 00 770009001 00      | 10                                                         | 7,15             |  |
| 10,00                                    | 210      | 150      | 2 | 00 827010001 00                                    | 1 8           | 6,83             | 00 770010001 00      | 10                                                         | 6,18             |  |
| 12,00                                    | 210      | 150      | 2 | 00 827012001 00                                    | 1 8           | 8,47             | 00 770012001 00      | 5                                                          | 7,83             |  |
| 14,00                                    | 210      | 150      | 2 | 00 827014001 00                                    | 1 8           | 11,11            | 00 770014001 00      | 5                                                          | 10,46            |  |
| 15,00                                    | 210      | 150      | 2 | 00 827015001 00                                    | 1 8           | 12,55            | 00 770015001 00      | 5                                                          | 11,91            |  |
| 16,00                                    | 210      | 150      | 2 | 00 827016001 00                                    | 1 8           | 13,96            | 00 770016001 00      | 5                                                          | 13,34            |  |
| 18,00                                    | 210      | 150      | 2 | 00 827018001 00                                    | 1 8           | 18,00            | 00 770018001 00      | 5                                                          | 17,50            |  |
| 19,00                                    | 210      | 150      | 2 | 00 827019001 00                                    | 1 8           | 19,00            | 00 770019001 00      | 5                                                          | 18,50            |  |
| 20,00                                    | 210      | 150      | 2 | 00 827020001 00                                    | 1 8           | 21,50            | 00 770020001 00      | 5                                                          | 21,00            |  |

| ▶ Länge   Length   Lunghezza: 260/200 mm |          |          |   | Code 837        |               |                  |                 | Code 771      |                  |  |
|------------------------------------------|----------|----------|---|-----------------|---------------|------------------|-----------------|---------------|------------------|--|
| Ø<br>mm                                  | l1<br>mm | l2<br>mm | Z | Art.-Nr.        | Inh.<br>Cont. | € /Stk.<br>€/pc. | Art.-Nr.        | Inh.<br>Cont. | € /Stk.<br>€/pc. |  |
| 5,50                                     | 260      | 200      | 2 | 00 837005501 00 | 1 8           | 10,22            |                 |               |                  |  |
| 6,00                                     | 260      | 200      | 2 | 00 837006001 00 | 1 8           | 9,30             | 00 771006001 00 | 10            | 8,65             |  |
| 6,50                                     | 260      | 200      | 2 | 00 837006501 00 | 1 8           | 9,30             | 00 771006501 00 | 10            | 8,65             |  |
| 7,00                                     | 260      | 200      | 2 | 00 837007001 00 | 1 8           | 8,60             | 00 771007001 00 | 10            | 7,93             |  |
| 8,00                                     | 260      | 200      | 2 | 00 837008001 00 | 1 8           | 8,60             | 00 771008001 00 | 10            | 7,93             |  |
| 9,50                                     | 260      | 200      | 2 | 00 837009501 00 | 1 8           | 9,50             | 00 771009501 00 | 10            | 8,83             |  |
| 10,00                                    | 260      | 200      | 2 | 00 837010001 00 | 1 8           | 9,50             | 00 771010001 00 | 10            | 8,83             |  |
| 11,00                                    | 260      | 200      | 2 | 00 837011001 00 | 1 8           | 10,74            | 00 771011001 00 | 5             | 10,08            |  |
| 12,00                                    | 260      | 200      | 2 | 00 837012001 00 | 1 8           | 10,74            | 00 771012001 00 | 5             | 10,08            |  |
| 13,00                                    | 260      | 200      | 2 | 00 837013001 00 | 1 8           | 12,61            | 00 771013001 00 | 5             | 11,97            |  |
| 14,00                                    | 260      | 200      | 2 | 00 837014001 00 | 1 8           | 13,79            | 00 771014001 00 | 5             | 13,14            |  |
| 15,00                                    | 260      | 200      | 2 | 00 837015001 00 | 1 8           | 15,80            | 00 771015001 00 | 5             | 15,16            |  |
| 16,00                                    | 260      | 200      | 2 | 00 837016001 00 | 1 8           | 16,25            | 00 771016001 00 | 5             | 15,54            |  |
| 18,00                                    | 260      | 200      | 2 | 00 837018001 00 | 1 8           | 19,07            | 00 771018001 00 | 5             | 18,58            |  |
| 20,00                                    | 260      | 200      | 2 | 00 837020001 00 | 1 8           | 21,28            | 00 771020001 00 | 5             | 20,70            |  |
| 22,00                                    | 260      | 200      | 2 | 00 837022001 00 | 1 8           | 35,00            |                 |               |                  |  |
| 24,00                                    | 260      | 200      | 2 | 00 837024001 00 | 1 8           | 40,00            |                 |               |                  |  |
| 25,00                                    | 260      | 200      | 2 | 00 837025001 00 | 1 8           | 45,00            |                 |               |                  |  |
| 26,00                                    | 260      | 200      | 2 | 00 837026001 00 | 1 8           | 48,00            |                 |               |                  |  |

Fortsetzung auf Seite VIII/6 | Continued on page VIII/6 | Segue a pagina VIII/6



## >> SDS-PLUS HAMMERBOHRER „F4“, 2 SCHNEIDEN

## SDS-PLUS HAMMER DRILLS „F4“, 2 CUTTING EDGES

## PERFORATORI SDS-PLUS „F4“, 2 TAGLIENTI

Fortsetzung von Seite VIII/5 | Continued from page VIII/5 | Segue da pagina VIII/5

| ▶ Länge   Length   Lunghezza: 310/250 mm |          |          |   | Plastiktasche   Plastic wallet<br>Confezione busta |               |                  | Gewerbepack   Industrial packing<br>Confezione industriale |               |                  |
|------------------------------------------|----------|----------|---|----------------------------------------------------|---------------|------------------|------------------------------------------------------------|---------------|------------------|
| Ø<br>mm                                  | l1<br>mm | l2<br>mm | Z | Code 847<br>Art.-Nr.                               | Inh.<br>Cont. | € /Stk.<br>€/pc. | Code 773<br>Art.-Nr.                                       | Inh.<br>Cont. | € /Stk.<br>€/pc. |
| 5,50                                     | 310      | 250      | 2 | 00 847005501 00                                    | 1 8           | 15,46            |                                                            |               |                  |
| 6,00                                     | 310      | 250      | 2 | 00 847006001 00                                    | 1 8           | 14,06            | 00 773006001 00                                            | 10            | 13,40            |
| 6,50                                     | 310      | 250      | 2 | 00 847006501 00                                    | 1 8           | 15,46            |                                                            |               |                  |
| 7,00                                     | 310      | 250      | 2 | 00 847007001 00                                    | 1 8           | 14,06            | 00 773007001 00                                            | 10            | 13,40            |
| 8,00                                     | 310      | 250      | 2 | 00 847008001 00                                    | 1 8           | 13,21            | 00 773008001 00                                            | 10            | 12,55            |
| 10,00                                    | 310      | 250      | 2 | 00 847010001 00                                    | 1 8           | 13,14            | 00 773010001 00                                            | 10            | 12,49            |
| 12,00                                    | 310      | 250      | 2 | 00 847012001 00                                    | 1 8           | 16,15            | 00 773012001 00                                            | 5             | 15,48            |
| 13,00                                    | 310      | 250      | 2 | 00 847013001 00                                    | 1 8           | 14,97            | 00 773013001 00                                            | 5             | 14,30            |
| 14,00                                    | 310      | 250      | 2 | 00 847014001 00                                    | 1 8           | 15,56            | 00 773014001 00                                            | 5             | 14,89            |
| 16,00                                    | 310      | 250      | 2 | 00 847016001 00                                    | 1 8           | 23,03            | 00 773016001 00                                            | 5             | 22,38            |
| 18,00                                    | 310      | 250      | 2 | 00 847018001 00                                    | 1 8           | 29,00            | 00 773018001 00                                            | 5             | 28,30            |
| 19,00                                    | 310      | 250      | 2 | 00 847019001 00                                    | 1 8           | 31,00            | 00 773019001 00                                            | 5             | 30,30            |
| 20,00                                    | 310      | 250      | 2 | 00 847020001 00                                    | 1 8           | 34,00            | 00 773020001 00                                            | 5             | 33,30            |
| 22,00                                    | 310      | 250      | 2 | 00 847022001 00                                    | 1 8           | 36,00            |                                                            |               |                  |
| 24,00                                    | 310      | 250      | 2 | 00 847024001 00                                    | 1 8           | 45,00            |                                                            |               |                  |
| 25,00                                    | 310      | 250      | 2 | 00 847025001 00                                    | 1 8           | 50,00            |                                                            |               |                  |

▶ Länge | Length | Lunghezza: 450/400 mm

| Ø<br>mm | l1<br>mm | l2<br>mm | Z | Code 877<br>Art.-Nr. | Inh.<br>Cont. | € /Stk.<br>€/pc. | Code 778<br>Art.-Nr. | Inh.<br>Cont. | € /Stk.<br>€/pc. |
|---------|----------|----------|---|----------------------|---------------|------------------|----------------------|---------------|------------------|
| 5,50    | 450      | 400      | 2 | 00 877005501 00      | 1 5           | 23,74            |                      |               |                  |
| 6,00    | 450      | 400      | 2 | 00 877006001 00      | 1 5           | 21,58            | 00 778006001 00      | 10            | 20,67            |
| 6,50    | 450      | 400      | 2 | 00 877006501 00      | 1 5           | 16,91            |                      |               |                  |
| 8,00    | 450      | 400      | 2 | 00 877008001 00      | 1 5           | 15,37            | 00 778008001 00      | 10            | 14,70            |
| 10,00   | 450      | 400      | 2 | 00 877010001 00      | 1 5           | 16,78            | 00 778010001 00      | 10            | 16,15            |
| 12,00   | 450      | 400      | 2 | 00 877012001 00      | 1 5           | 18,87            | 00 778012001 00      | 5             | 18,21            |
| 13,00   | 450      | 400      | 2 | 00 877013001 00      | 1 5           | 19,77            | 00 778013001 00      | 5             | 19,13            |
| 14,00   | 450      | 400      | 2 | 00 877014001 00      | 1 5           | 20,56            | 00 778014001 00      | 5             | 19,91            |
| 15,00   | 450      | 400      | 2 | 00 877015001 00      | 1 5           | 25,92            | 00 778015001 00      | 5             | 25,28            |
| 16,00   | 450      | 400      | 2 | 00 877016001 00      | 1 5           | 30,29            | 00 778016001 00      | 5             | 29,60            |
| 18,00   | 450      | 400      | 2 | 00 877018001 00      | 1 5           | 31,72            | 00 778018001 00      | 5             | 31,08            |
| 19,00   | 450      | 400      | 2 | 00 877019001 00      | 1 5           | 37,52            | 00 778019001 00      | 5             | 36,82            |
| 20,00   | 450      | 400      | 2 | 00 877020001 00      | 1 5           | 37,52            | 00 778020001 00      | 5             | 36,82            |
| 22,00   | 450      | 400      | 2 | 00 877022001 00      | 1 5           | 39,36            |                      |               |                  |
| 24,00   | 450      | 400      | 2 | 00 877024001 00      | 1 5           | 52,15            |                      |               |                  |
| 25,00   | 450      | 400      | 2 | 00 877025001 00      | 1 5           | 56,23            |                      |               |                  |
| 26,00   | 450      | 400      | 2 | 00 877026001 00      | 1 5           | 61,61            |                      |               |                  |

▶ Länge | Length | Lunghezza: 600/550 mm

| Ø<br>mm | l1<br>mm | l2<br>mm | Z | Code 887<br>Art.-Nr. | Inh.<br>Cont. | € /Stk.<br>€/pc. |
|---------|----------|----------|---|----------------------|---------------|------------------|
| 10,00   | 600      | 550      | 2 | 00 887010001 00      | 1 5           | 28,30            |
| 12,00   | 600      | 550      | 2 | 00 887012001 00      | 1 5           | 28,30            |
| 14,00   | 600      | 550      | 2 | 00 887014001 00      | 1 5           | 31,79            |
| 16,00   | 600      | 550      | 2 | 00 887016001 00      | 1 5           | 32,26            |
| 18,00   | 600      | 550      | 2 | 00 887018001 00      | 1 5           | 49,36            |
| 20,00   | 600      | 550      | 2 | 00 887020001 00      | 1 5           | 50,31            |
| 24,00   | 600      | 550      | 2 | 00 887024001 00      | 1 5           | 70,00            |
| 25,00   | 600      | 550      | 2 | 00 887025001 00      | 1 5           | 75,00            |

Fortsetzung auf Seite VIII/7 | Continued on page VIII/7 | Segue a pagina VIII/7





>> **SDS-PLUS HAMMERBOHRER  
„F4“, 2 SCHNEIDEN**

**SDS-PLUS HAMMER DRILLS  
“F4”, 2 CUTTING EDGES**

**PERFORATORI SDS-PLUS  
„F4“, 2 TAGLIENTI**

Fortsetzung von Seite VIII/6 | Continued from page VIII/6 | Segue da pagina VIII/6

| ▶ Länge   Length   Lunghezza: 800/740 mm  |          |          |   | Plastiktasche   Plastic wallet<br>Confezione busta |               |                                                                                   |                 |
|-------------------------------------------|----------|----------|---|----------------------------------------------------|---------------|-----------------------------------------------------------------------------------|-----------------|
| Ø<br>mm                                   | l1<br>mm | l2<br>mm | Z | Code 913<br>Art.-Nr.                               | Inh.<br>Cont. |  | €/Stk.<br>€/pc. |
| 12,00                                     | 800      | 740      | 2 | 00 913012001 00                                    | 1             | 1                                                                                 | 43,77           |
| 16,00                                     | 800      | 740      | 2 | 00 913016001 00                                    | 1             | 1                                                                                 | 52,86           |
| 20,00                                     | 800      | 740      | 2 | 00 913020001 00                                    | 1             | 1                                                                                 | 77,72           |
| ▶ Länge   Length   Lunghezza: 1000/950 mm |          |          |   |                                                    |               |                                                                                   |                 |
| Ø<br>mm                                   | l1<br>mm | l2<br>mm | Z | Code 914<br>Art.-Nr.                               | Inh.<br>Cont. |  | €/Stk.<br>€/pc. |
| 10,00                                     | 1000     | 950      | 2 | 00 914010001 00                                    | 1             | 1                                                                                 | 63,72           |
| 12,00                                     | 1000     | 950      | 2 | 00 914012001 00                                    | 1             | 1                                                                                 | 63,72           |
| 14,00                                     | 1000     | 950      | 2 | 00 914014001 00                                    | 1             | 1                                                                                 | 74,03           |
| 16,00                                     | 1000     | 950      | 2 | 00 914016001 00                                    | 1             | 1                                                                                 | 89,83           |
| 18,00                                     | 1000     | 950      | 2 | 00 914018001 00                                    | 1             | 1                                                                                 | 91,44           |
| 20,00                                     | 1000     | 950      | 2 | 00 914020001 00                                    | 1             | 1                                                                                 | 95,89           |
| 25,00                                     | 1000     | 950      | 2 | 00 914025001 00                                    | 1             | 1                                                                                 | 123,48          |



## >> SDS-PLUS HAMMERBOHRER „F8“, 4 SCHNEIDEN

### Einsatzbereich:

SDS-plus Hochleistungsbohrer mit 4 Vollhartmetall-Schneiden, besonders geeignet zum Bohren in armierten Beton. Problemloses Durchbohren von Eisenarmierungen, vibrationsarmer Lauf und schnelle Bohrmehlförderung.

#### EXAKT

durch  
symmetrische 4x  
90°-Kopfgeometrie

#### SCHNELL

durch  
4-fach-Spirale

## SDS-PLUS HAMMER DRILLS “F8”, 4 CUTTING EDGES

### Range of application:

SDS-plus high performance drill with 4 tungsten carbide cutting edges, especially suitable for drilling in reinforced concrete. Problem-free drilling in reinforced concrete, vibrationless running and fast removal of drilling dust.

#### PRECISE

thanks to  
symmetrical 4x  
90°-tip geometry

#### FAST

thanks to  
4 flutes

## PERFORATORI SDS-PLUS “F8”, 4 TAGLIANTI

### Impiego:

Punte SDS-plus ad alto rendimento con 4 taglienti in M.D., particolarmente adatte per la foratura di cemento armato. Foratura senza problemi di armature in ferro, minime vibrazioni nella corsa, e veloce evacuazione delle polveri.

#### ESATTO

grazie alla geometria  
simmetrica  
4x 90° della testa

#### VELOCE

grazie alla spirale  
a 4 scanalature

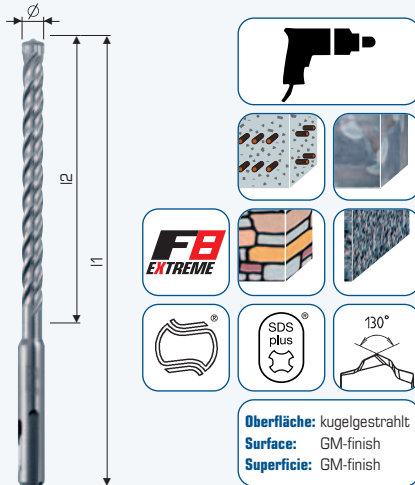

► Länge | Length | Lunghezza: 110/50 mm

| $\phi$<br>mm | L1<br>mm | L2<br>mm | Z | Code 806<br>Art.-Nr. | Inh.<br>Cont. | € /Stk.<br>€ /pc. |
|--------------|----------|----------|---|----------------------|---------------|-------------------|
| 5,00         | 110      | 50       | 4 | 00 806005001 00      | 1 10          | 8,08              |
| 6,00         | 110      | 50       | 4 | 00 806006001 00      | 1 10          | 8,29              |

► Länge | Length | Lunghezza: 160/100 mm

| $\phi$<br>mm | L1<br>mm | L2<br>mm | Z | Code 816<br>Art.-Nr. | Inh.<br>Cont. | € /Stk.<br>€ /pc. |
|--------------|----------|----------|---|----------------------|---------------|-------------------|
| 5,00         | 160      | 100      | 4 | 00 816005001 00      | 1 10          | 9,84              |
| 5,50         | 160      | 100      | 4 | 00 816005501 00      | 1 10          | 12,11             |
| 6,00         | 160      | 100      | 4 | 00 816006001 00      | 1 10          | 9,21              |
| 7,00         | 160      | 100      | 4 | 00 816007001 00      | 1 10          | 11,97             |
| 8,00         | 160      | 100      | 4 | 00 816008001 00      | 1 10          | 11,41             |
| 10,00        | 160      | 100      | 4 | 00 816010001 00      | 1 10          | 13,81             |
| 12,00        | 160      | 100      | 4 | 00 816012001 00      | 1 10          | 17,36             |

► Länge | Length | Lunghezza: 260/200 mm

| $\phi$<br>mm | L1<br>mm | L2<br>mm | Z | Code 836<br>Art.-Nr. | Inh.<br>Cont. | € /Stk.<br>€ /pc. |
|--------------|----------|----------|---|----------------------|---------------|-------------------|
| 6,00         | 260      | 200      | 4 | 00 836006001 00      | 1 10          | 15,00             |
| 6,50         | 260      | 200      | 4 | 00 836006501 00      | 1 10          | 19,83             |
| 8,00         | 260      | 200      | 4 | 00 836008001 00      | 1 10          | 17,00             |
| 10,00        | 260      | 200      | 4 | 00 836010001 00      | 1 10          | 21,61             |
| 12,00        | 260      | 200      | 4 | 00 836012001 00      | 1 10          | 25,14             |
| 14,00        | 260      | 200      | 4 | 00 836014001 00      | 1 10          | 39,90             |

Fortsetzung auf Seite VIII/9 | Continued on page VIII/9 | Segue a pagina VIII/9



Plastiktasche | Plastic wallet  
Confezione busta



NEU | NEW | NUOVO



>> **SDS-PLUS HAMMERBOHRER  
„F8“, 4 SCHNEIDEN**

**SDS-PLUS HAMMER DRILLS  
“F8”, 4 CUTTING EDGES**

**PERFORATORI SDS-PLUS  
“F8”, 4 TAGLIENTI**

Fortsetzung von Seite VIII/8 | Continued from page VIII/8 | Segue da pagina VIII/8

| ▶ Länge   Length   Lunghezza: 310/250 mm |          |          |   | Plastiktasche   Plastic wallet<br>Confezione busta |               |    |                 |
|------------------------------------------|----------|----------|---|----------------------------------------------------|---------------|----|-----------------|
| Ø<br>mm                                  | l1<br>mm | l2<br>mm | Z | Code 846<br>Art.-Nr.                               | Inh.<br>Cont. |    | €/Stk.<br>€/pc. |
| 6,00                                     | 310      | 250      | 4 | 00 846006001 00                                    | 1             | 10 | 29,35           |
| 8,00                                     | 310      | 250      | 4 | 00 846008001 00                                    | 1             | 10 | 30,00           |
| 10,00                                    | 310      | 250      | 4 | 00 846010001 00                                    | 1             | 10 | 30,11           |
| 12,00                                    | 310      | 250      | 4 | 00 846012001 00                                    | 1             | 10 | 32,58           |

| ▶ Länge   Length   Lunghezza: 450/400 mm |          |          |   |                      |               |    |                 |
|------------------------------------------|----------|----------|---|----------------------|---------------|----|-----------------|
| Ø<br>mm                                  | l1<br>mm | l2<br>mm | Z | Code 876<br>Art.-Nr. | Inh.<br>Cont. |    | €/Stk.<br>€/pc. |
| 8,00                                     | 460      | 400      | 4 | 00 876008001 00      | 1             | 10 | 30,11           |
| 10,00                                    | 450      | 400      | 4 | 00 876010001 00      | 1             | 10 | 35,77           |
| 12,00                                    | 450      | 400      | 4 | 00 876012001 00      | 1             | 10 | 39,67           |
| 14,00                                    | 450      | 400      | 4 | 00 876014001 00      | 1             | 10 | 50,83           |



## >> HAMMERFESTE SDS-PLUS BOHRKRONE

### Einsatzbereich:

Hammerfeste Schlagbohrkrone mit hochfestem Kronengrundkörper und Hartmetallschneiden in Hammerbohrerqualität. Für Beton und Mauerwerk.

#### ROBUST

durch hochbelastbare Hartmetallschneiden

#### LEISTUNGSSTARK

durch hochfesten Kronengrundkörper

## HAMMER-ACTIVE SDS-PLUS CORE BIT

### Range of application:

Hammer-active core bit with high strength base body and carbide tips in SDS hammer drilling quality, for concrete and masonry.

#### ROBUST

thanks to tungsten-carbide tips

#### EFFICIENT

thanks to high-strength base body

## PUNTE A CORONA SDS-PLUS

### Impiego:

Punte a corona a percussione con corona base del corpo ad alta resistenza, taglienti in M.D. in materiale delle punte per martelli pneumatici. Per cemento e muro.

#### SOLIDE

grazie agli inserti in metallo duro

#### POTENTI

grazie al corpo della corona

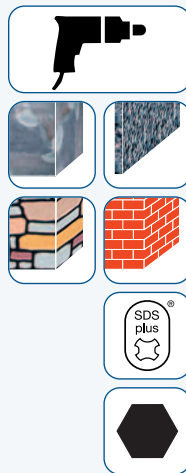
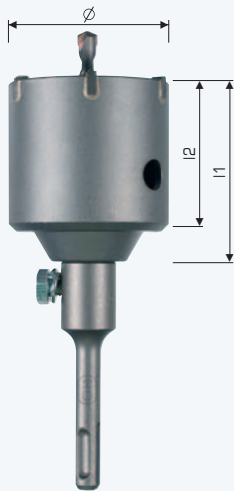

Einzelverpackung | Single packing  
Imballo singolo

### ► Bohrkronen komplett | Corebits ready for use | Corona completa

| Ø<br>mm              | l1<br>mm | l2<br>mm | Z |          | Code 897<br>Art.-Nr. | Inh.<br>Cont. | €/Stk.<br>€/pc. |
|----------------------|----------|----------|---|----------|----------------------|---------------|-----------------|
| 40,00 <sup>(1)</sup> | 70       | 65       | 4 | SDS-plus | 00 897040001 00      | 1             | 87,03           |
| 65,00 <sup>(2)</sup> | 70       | 65       | 6 | SDS-plus | 00 897065001 00      | 1             | 94,19           |
| 80,00 <sup>(2)</sup> | 70       | 65       | 6 | SDS-plus | 00 897080001 00      | 1             | 113,32          |

### ► Aufnahmeschaft einzeln | Single arbor | Guida portautensile (1 pz.)

| Ø<br>mm  | l1<br>mm |     | Code 898<br>Art.-Nr. | Inh.<br>Cont. | €/Stk.<br>€/pc. |
|----------|----------|-----|----------------------|---------------|-----------------|
| 6        | 95       | M16 | 00 898000951 00      | 1             | 17,84           |
| SDS-plus | 110      | M16 | 00 898001101 00      | 1             | 20,69           |
| SDS-plus | 220      | M16 | 00 898002001 00      | 1             | 29,96           |

### ► Zentrierbohrer einzeln | Single pilot drill | Punta a centrare (1 pz.)

| Ø<br>mm | l1<br>mm | l2<br>mm | Code 899<br>Art.-Nr. | Inh.<br>Cont. | €/Stk.<br>€/pc. |
|---------|----------|----------|----------------------|---------------|-----------------|
| 8,00    | 110      | 70       | 00 899008001 00      | 1             | 7,12            |

### ► Bohrkronen einzeln | Single core bit | Solo corona (1 pz.)

| Ø<br>mm | l1<br>mm | l2<br>mm | Z |     | Code 896<br>Art.-Nr. | Inh.<br>Cont. | €/Stk.<br>€/pc. |
|---------|----------|----------|---|-----|----------------------|---------------|-----------------|
| 40,00   | 70       | 65       | 4 | M16 | 00 896040001 00      | 1             | 58,97           |
| 65,00   | 70       | 65       | 6 | M16 | 00 896065001 00      | 1             | 66,38           |
| 80,00   | 70       | 65       | 6 | M16 | 00 896080001 00      | 1             | 82,09           |

<sup>(1)</sup> Maschinenleistung ≥ 600 W | Machine power (input) ≥ 600 W | Potenza macchina ≥ 600 W

<sup>(2)</sup> Maschinenleistung ≥ 800 W | Machine power (input) ≥ 800 W | Potenza macchina ≥ 800 W



## >> SDS-PLUS MEISSEL

## SDS-PLUS CHISELS

## SCALPELLI SDS-PLUS

### Einsatzbereich:

Für alle Bohrhämmer mit SDS-plus Aufnahme.  
Zum Bearbeiten von Beton, Naturstein, Mauerwerk.

### Range of application:

For heavy-duty SDS-plus hammer chiseling of concrete, natural stone, masonry.

### Impiego:

Per tutti i martelli con attacco SDS-plus.  
Adatte per lavorazione di cemento, pietre naturali, calcestruzzo.

#### LEISTUNGSSTARK

durch modernste  
Vakuumbhärtung

#### ROBUST

durch Spezial-  
schmiedestahl

#### EFFICIENT

thanks to state-  
of-the-art vacuum  
hardening

#### ROBUST

thanks to special  
forged steel

#### RENDIMENTO

grazie al tratta-  
mento termico  
sottovuoto

#### ROBUSTO

grazie all'impiego  
di speciali acciai  
forgiati

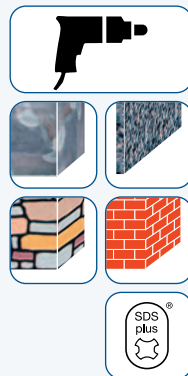
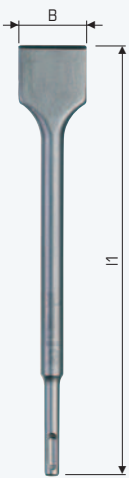

**Oberfläche:** kugelgestrahlt  
**Surface:** GM-finish  
**Superficie:** GM-finish



SB-Aufhänger | Plastic tag  
Placchetta plastica



|                                                                     | l1<br>mm | B<br>mm | Code<br>Art.-Nr.                   | Inh.<br>Cont.               | € /Stk.<br>€ /pc.               |
|---------------------------------------------------------------------|----------|---------|------------------------------------|-----------------------------|---------------------------------|
|                                                                     |          |         | <b>Code 980</b><br><b>Art.-Nr.</b> | <b>Inh.</b><br><b>Cont.</b> | <b>€ /Stk.</b><br><b>€ /pc.</b> |
| <b>Spitz   Point   Punta</b>                                        | 250      |         | 00 980002501 00                    | 1 1                         | <b>16,63</b>                    |
| <b>Spitz   Point   Punta</b>                                        | 250      |         | 00 980012501 00                    | 1 10*                       | <b>14,38</b>                    |
|                                                                     |          |         | <b>Code 981</b><br><b>Art.-Nr.</b> | <b>Inh.</b><br><b>Cont.</b> | <b>€ /Stk.</b><br><b>€ /pc.</b> |
| <b>Flach   Flat   Taglio piatto</b>                                 | 250      | 20      | 00 981002501 00                    | 1 1                         | <b>16,63</b>                    |
| <b>Flach   Flat   Taglio piatto</b>                                 | 250      | 20      | 00 981012501 00                    | 1 10*                       | <b>14,38</b>                    |
|                                                                     |          |         | <b>Code 982</b><br><b>Art.-Nr.</b> | <b>Inh.</b><br><b>Cont.</b> | <b>€ /Stk.</b><br><b>€ /pc.</b> |
| <b>Breit   Wide   Taglio largo</b>                                  | 250      | 40      | 00 982004251 00                    | 1 1                         | <b>23,08</b>                    |
| <b>Breit   Wide   Taglio largo</b>                                  | 250      | 40      | 00 982014251 00                    | 1 10*                       | <b>20,87</b>                    |
|                                                                     |          |         | <b>Code 983</b><br><b>Art.-Nr.</b> | <b>Inh.</b><br><b>Cont.</b> | <b>€ /Stk.</b><br><b>€ /pc.</b> |
| <b>Fliesenmeißel<br/>Tiles chisel   Scalpello per piastrelle</b>    | l1<br>mm | B<br>mm | Code 983<br>Art.-Nr.               | Inh.<br>Cont.               | € /Stk.<br>€ /pc.               |
| <b>Breit gekröpft   Wide, cranked   Taglio largo angolo inverso</b> | 250      | 50      | 00 983005051 00                    | 1 1                         | <b>29,38</b>                    |
|                                                                     |          |         | <b>Code 983</b><br><b>Art.-Nr.</b> | <b>Inh.</b><br><b>Cont.</b> | <b>€ /Stk.</b><br><b>€ /pc.</b> |
| <b>Hohl   Gouge   Sgorbia</b>                                       | 250      | 22      | 00 983002251 00                    | 1 1                         | <b>29,38</b>                    |
|                                                                     |          |         | <b>Code 984</b><br><b>Art.-Nr.</b> | <b>Inh.</b><br><b>Cont.</b> | <b>€ /Stk.</b><br><b>€ /pc.</b> |
| <b>Flügel   Winged gouge   Alette</b>                               | 250      | 22      | 00 984002251 00                    | 1 1                         | <b>60,55</b>                    |

\* ohne SB-Aufhänger  
without plastic tag  
senza placchetta di plastica

## >> SDS-MAX HAMMERBOHRER

### Einsatzbereich:

Für alle Bohrhämmer mit SDS-max Aufnahme.  
Zum Hammerbohren in Beton, Naturstein und Mauerwerk.

### LEISTUNGSSTARK [ ROBUST ]

durch Kugelstrahlhärtung

durch hochbelastbare Hartmetallspitze

## SDS-MAX HAMMER DRILLS

### Range of application:

High efficiency drill for heavy-duty SDS-max hammer drilling of concrete, natural stone, masonry.

### EFFICIENT [ ROBUST ]

thanks to state-of-the-art hardening

thanks to high-strength tungsten-carbide tip

## PERFORATORI SDS-MAX

### Impiego:

Adatte per tutti i tipi di martelli pneumatici con attacco tipo SDS-max per foratura di cemento, pietre naturali e muro.

### RENDIMENTO [ ROBUSTA ]

grazie al trattamento di pallinatura

grazie alla particolare affilatura della placchetta

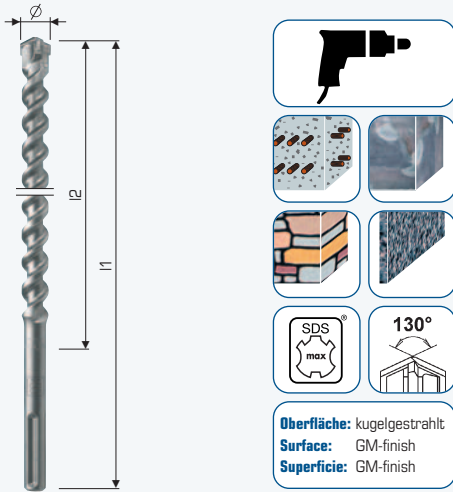

► Arbeitslänge | Working depth | Lunghezza utile: 200 mm



SB-Aufhänger | Plastic tag  
Placchetta plastica



| Ø<br>mm | l1<br>mm | l2<br>mm | Z | Code 889<br>Art.-Nr. | Inh.<br>Cont. | €/Stk.<br>€/pc. |
|---------|----------|----------|---|----------------------|---------------|-----------------|
| 12,00   | 340      | 200      | 2 | 00 889012001 00      | 1 1           | 60,00           |
| 13,00   | 340      | 200      | 2 | 00 889013001 00      | 1 1           | 61,19           |
| 14,00   | 340      | 200      | 2 | 00 889014001 00      | 1 1           | 65,47           |
| 15,00   | 340      | 200      | 2 | 00 889015001 00      | 1 1           | 71,65           |
| 16,00   | 340      | 200      | 4 | 00 889016001 00      | 1 1           | 74,83           |
| 18,00   | 340      | 200      | 4 | 00 889018001 00      | 1 1           | 77,52           |
| 19,00   | 340      | 200      | 4 | 00 889019001 00      | 1 1           | 76,13           |
| 20,00   | 320      | 200      | 4 | 00 889020001 00      | 1 1           | 76,13           |
| 22,00   | 320      | 200      | 4 | 00 889022001 00      | 1 1           | 84,36           |
| 24,00   | 320      | 200      | 4 | 00 889024001 00      | 1 1           | 88,39           |
| 25,00   | 320      | 200      | 4 | 00 889025001 00      | 1 1           | 90,41           |
| 26,00   | 340      | 200      | 4 | 00 889026001 00      | 1 1           | 103,72          |

► Arbeitslänge | Working depth | Lunghezza utile: 250 mm

| Ø<br>mm | l1<br>mm | l2<br>mm | Z | Code 890<br>Art.-Nr. | Inh.<br>Cont. | €/Stk.<br>€/pc. |
|---------|----------|----------|---|----------------------|---------------|-----------------|
| 28,00   | 370      | 250      | 4 | 00 890028001 00      | 1 1           | 103,72          |
| 30,00   | 370      | 250      | 4 | 00 890030001 00      | 1 1           | 108,92          |
| 32,00   | 370      | 250      | 4 | 00 890032001 00      | 1 1           | 112,97          |
| 35,00   | 370      | 250      | 4 | 00 890035001 00      | 1 1           | 130,43          |
| 38,00   | 370      | 250      | 4 | 00 890038001 00      | 1 1           | 154,75          |
| 40,00   | 370      | 250      | 4 | 00 890040001 00      | 1 1           | 173,04          |

Fortsetzung auf Seite VIII/13 | Continued on page VIII/13 | Segue a pagina VIII/13

Fortsetzung von Seite VIII/12 | Continued from page VIII/12 | Segue da pagina VIII/12

|                                                           |      |      |   | SB-Aufhänger   Plastic tag<br>Placchetta plastica |       |         |
|-----------------------------------------------------------|------|------|---|---------------------------------------------------|-------|---------|
| ▶ Arbeitslänge   Working depth   Lunghezza utile: 400 mm  |      |      |   | Code 891                                          | Inh.  | € /Stk. |
| Ø                                                         | l1   | l2   | Z | Art.-Nr.                                          | Cont. | €/pc.   |
| 12,00                                                     | 540  | 400  | 2 | 00 891012001 00                                   | 1 1   | 74,22   |
| 13,00                                                     | 540  | 400  | 2 | 00 891013001 00                                   | 1 1   | 75,91   |
| 14,00                                                     | 540  | 400  | 2 | 00 891014001 00                                   | 1 1   | 78,95   |
| 15,00                                                     | 540  | 400  | 2 | 00 891015001 00                                   | 1 1   | 83,40   |
| 16,00                                                     | 540  | 400  | 4 | 00 891016001 00                                   | 1 1   | 83,82   |
| 18,00                                                     | 540  | 400  | 4 | 00 891018001 00                                   | 1 1   | 86,51   |
| 19,00                                                     | 540  | 400  | 4 | 00 891019001 00                                   | 1 1   | 87,16   |
| 20,00                                                     | 520  | 400  | 4 | 00 891020001 00                                   | 1 1   | 87,16   |
| 22,00                                                     | 520  | 400  | 4 | 00 891022001 00                                   | 1 1   | 91,49   |
| 24,00                                                     | 520  | 400  | 4 | 00 891024001 00                                   | 1 1   | 104,66  |
| 25,00                                                     | 520  | 400  | 4 | 00 891025001 00                                   | 1 1   | 106,42  |
| 26,00                                                     | 520  | 400  | 4 | 00 891026001 00                                   | 1 1   | 109,23  |
| ▶ Arbeitslänge   Working depth   Lunghezza utile: 450 mm  |      |      |   | Code 892                                          | Inh.  | € /Stk. |
| Ø                                                         | l1   | l2   | Z | Art.-Nr.                                          | Cont. | €/pc.   |
| 28,00                                                     | 570  | 450  | 4 | 00 892028001 00                                   | 1 1   | 116,09  |
| 30,00                                                     | 570  | 450  | 4 | 00 892030001 00                                   | 1 1   | 127,00  |
| 32,00                                                     | 570  | 450  | 4 | 00 892032001 00                                   | 1 1   | 136,35  |
| 35,00                                                     | 570  | 450  | 4 | 00 892035001 00                                   | 1 1   | 146,13  |
| 38,00                                                     | 570  | 450  | 4 | 00 892038001 00                                   | 1 1   | 170,34  |
| 40,00                                                     | 570  | 450  | 4 | 00 892040001 00                                   | 1 1   | 195,38  |
| 45,00                                                     | 570  | 450  | 4 | 00 892045001 00                                   | 1 1   | 288,61  |
| 50,00                                                     | 570  | 450  | 4 | 00 892050001 00                                   | 1 1   | 346,50  |
| ▶ Arbeitslänge   Working depth   Lunghezza utile: 550 mm  |      |      |   | Code 893                                          | Inh.  | € /Stk. |
| Ø                                                         | l1   | l2   | Z | Art.-Nr.                                          | Cont. | €/pc.   |
| 12,00                                                     | 690  | 550  | 2 | 00 893012001 00                                   | 1 1   | 99,33   |
| 28,00                                                     | 670  | 550  | 4 | 00 893028001 00                                   | 1 1   | 140,61  |
| 35,00                                                     | 670  | 550  | 4 | 00 893035001 00                                   | 1 1   | 163,48  |
| ▶ Arbeitslänge   Working depth   Lunghezza utile: 800 mm  |      |      |   | Code 894                                          | Inh.  | € /Stk. |
| Ø                                                         | l1   | l2   | Z | Art.-Nr.                                          | Cont. | €/pc.   |
| 16,00                                                     | 920  | 800  | 4 | 00 894016001 00                                   | 1 1   | 114,42  |
| 18,00                                                     | 940  | 800  | 4 | 00 894018001 00                                   | 1 1   | 118,48  |
| 20,00                                                     | 920  | 800  | 4 | 00 894020001 00                                   | 1 1   | 118,48  |
| 22,00                                                     | 920  | 800  | 4 | 00 894022001 00                                   | 1 1   | 133,13  |
| 25,00                                                     | 920  | 800  | 4 | 00 894025001 00                                   | 1 1   | 148,00  |
| 32,00                                                     | 920  | 800  | 4 | 00 894032001 00                                   | 1 1   | 195,28  |
| 40,00                                                     | 920  | 800  | 4 | 00 894040001 00                                   | 1 1   | 270,53  |
| ▶ Arbeitslänge   Working depth   Lunghezza utile: 1200 mm |      |      |   | Code 895                                          | Inh.  | € /Stk. |
| Ø                                                         | l1   | l2   | Z | Art.-Nr.                                          | Cont. | €/pc.   |
| 22,00                                                     | 1320 | 1200 | 4 | 00 895022001 00                                   | 1 1   | 264,71  |
| 25,00                                                     | 1320 | 1200 | 4 | 00 895025001 00                                   | 1 1   | 273,02  |
| 32,00                                                     | 1320 | 1200 | 4 | 00 895032001 00                                   | 1 1   | 332,78  |
| 40,00                                                     | 1320 | 1200 | 4 | 00 895040001 00                                   | 1 1   | 408,33  |



## >> SDS-MAX BOHRKRONE

### Einsatzbereich:

Die Hartmetall-Zähne ermöglichen hohe Standzeiten. Durch die wechselnde Zahnfolge können Bohren und Meißeln in einem Arbeitsgang durchgeführt werden. Zum Bearbeiten von Beton, Naturstein, Mauerwerk, Marmor und Klinker.



durch Hartmetall-Zähne

Durchschlagstark auch in armierten Beton

## SDS-MAX CORE BIT

### Range of application:

High durabilities are achieved due to the tungsten carbide teeth. Because of the changing tooth order, drilling and chiseling can be done in one operation. For heavy duty SDS-max hammer drilling of concrete, natural stone, masonry and marble.



by tungsten carbide teeth

Strong even in reinforced concrete

## PUNTE A CORONA SDS-MAX

### Impiego:

Grazie agli inserti in metallo duro si ottiene una elevata durata e grazie al posizionamento sfalsato degli stessi si può forare e scalpellare in unica passata. Per lavorazione di cemento, pietre, muri, marmo e Klinker.



grazie agli inserti in metallo duro

lavora anche in cemento armato

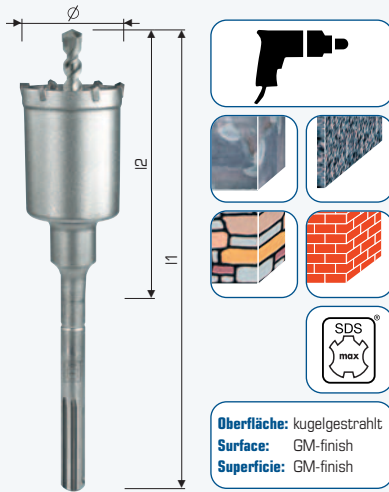

► Länge | Length | Lunghezza: 290/170 mm

| β<br>mm | l1<br>mm | l2*<br>mm | Z | Code 871<br>Art.-Nr. | Inh.<br>Cont. | € /Stk.<br>€/pc. |
|---------|----------|-----------|---|----------------------|---------------|------------------|
| 50,00   | 290      | 170       | 6 | 00 871050001 00      | 1 1           | 224,28           |
| 68,00   | 290      | 170       | 6 | 00 871068001 00      | 1 1           | 260,65           |
| 80,00   | 290      | 170       | 8 | 00 871080001 00      | 1 1           | 284,87           |

► Länge | Length | Lunghezza: 550/430 mm

| β<br>mm | l1<br>mm | l2*<br>mm | Z  | Code 872<br>Art.-Nr. | Inh.<br>Cont. | € /Stk.<br>€/pc. |
|---------|----------|-----------|----|----------------------|---------------|------------------|
| 40,00   | 550      | 430       | 6  | 00 872040001 00      | 1 1           | 224,28           |
| 50,00   | 550      | 430       | 6  | 00 872050001 00      | 1 1           | 236,33           |
| 68,00   | 550      | 430       | 6  | 00 872068001 00      | 1 1           | 290,90           |
| 80,00   | 550      | 430       | 8  | 00 872080001 00      | 1 1           | 333,40           |
| 90,00   | 550      | 430       | 8  | 00 872090001 00      | 1 1           | 357,62           |
| 100,00  | 550      | 430       | 10 | 00 872099991 00      | 1 1           | 387,86           |

► Zentrierbohrer für Bohrkronen | Centre drill for drilling crown | Punta da centro

| β<br>mm | l1<br>mm | Code 871<br>Art.-Nr. | Inh.<br>Cont. | € /Stk.<br>€/pc. |
|---------|----------|----------------------|---------------|------------------|
| 12,00   | 128      | 00 871012001 00      | 1 1           | 25,50            |

► Gewindefett | Thread grease | Grasso per filetti

| Inhalt<br>Contents   Contenuto | Code 888<br>Art.-Nr. | Inh.<br>Cont. | € /Stk.<br>€/pc. |
|--------------------------------|----------------------|---------------|------------------|
| 200 g                          | 00 888000021 00      | 1 1           | 11,37            |

\* Die Bohrtiefe setzt sich aus mehreren Schritten zusammen: jeweils nach Erreichen der Nutzlänge Kern ausbrechen.

\* The drilling depth is done in several steps: after reaching the working length break up the core.

\* La profondità del foro si ottiene in più passate: ogni volta raggiunta la lunghezza utile rompere il nucleo.



## >> SDS-MAX FRÄSKRONE

## SDS-MAX MILLING CROWN

## FRESE A TAZZA SDS-MAX

### Einsatzbereich:

Sicherer Ansatz auch in Ecken durch langen, auswechselbaren Zentrierbohrer. Exakte Bohrlochgeometrie auch bei tiefen Bohrlöchern. Durch asynchrone Bohrkopfstruktur schnelle Bohrmehlförderung. Zum Bearbeiten von Beton, Mauerwerk, Marmor und Klinker.

#### EXAKT

Exakte Bohrungen auch bei tiefen Löchern

#### SCHNELL

durch asynchrone Bohrkopfstruktur

### Range of application:

Safe fixing even in corners thanks to long, exchangeable centre drill. Precise geometry of the drilling hole even at deep holes. Due to the asynchronous structure of the drilling head the drilling dust will be moved faster. For heavy-duty cutting in concrete, masonry and marble.

#### EXACT

Precise drills even at deep holes

#### FAST

thanks to asynchronous drilling head

### Impiego:

Fissaggio sicuro anche in angoli grazie alla lunga punta da centro intercambiabile. Esatta geometria del foro, anche per fori profondi. Grazie alla struttura asincrona della testa porta punta si ha una veloce evacuazione delle polveri. Per lavorazione di cemento, muro, marmo e clinker.

#### ESATTA

precise anche in fori profondi

#### VELOCE

grazie alla testa asincrona

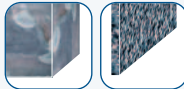

**Oberfläche:** kugelgestrahlt  
**Surface:** GM-finish  
**Superficie:** GM-finish

### Einzelverpackung | Single packing Imballo singolo

| Ø<br>mm | l1<br>mm | l2<br>mm | Code 888<br>Art.-Nr. | Inh.<br>Cont. | € /Stk.<br>€/pc. |
|---------|----------|----------|----------------------|---------------|------------------|
| 55,00   | 550      | 390      | 00 888055001 00      | 1 1           | 409,48           |
| 65,00   | 550      | 390      | 00 888065001 00      | 1 1           | 444,81           |
| 80,00   | 550      | 390      | 00 888080001 00      | 1 1           | 498,96           |

### ► Zentrierbohrer für Fräskrone Centre drill for milling crown Punta a centrare per frese a tazza

### Plastiktasche | Plastic wallet Confezione busta

| Ø<br>mm | l1<br>mm | Code 888<br>Art.-Nr. | Inh.<br>Cont. | € /Stk.<br>€/pc. |
|---------|----------|----------------------|---------------|------------------|
| 18,00   | 80       | 00 888018001 00      | 1 1           | 47,44            |

### ► Gewindefett | Thread grease | Grasso per filetti

### Dose | Can | Scatola

| Inhalt<br>Contents   Contenuto | Code 888<br>Art.-Nr. | Inh.<br>Cont. | € /Stk.<br>€/pc. |
|--------------------------------|----------------------|---------------|------------------|
| 200 g                          | 00 888000021 00      | 1 1           | 11,37            |



## >> SDS-MAX MEISSEL

### Einsatzbereich:

Für alle Bohrhämmer mit SDS-max Aufnahme.  
Zum Bearbeiten von Beton, Naturstein, Mauerwerk.

#### [LEISTUNGSSTARK] [ROBUST]

durch modernste  
Vakuumbhärtung

durch Spezial-  
schmiedestahl

## SDS-MAX CHISELS

### Range of application:

For heavy-duty SDS-max hammer chiseling of  
concrete, natural stone, masonry.

#### [EFFICIENT] [ROBUST]

thanks to state-  
of-the-art vacuum  
hardening

thanks to special  
forged steel

## SCALPELLI SDS-MAX

### Impiego:

Per tutti i martelli con attacco SDS-max.  
Adatte per lavorazione di cemento, pietre  
naturali, calcestruzzo.







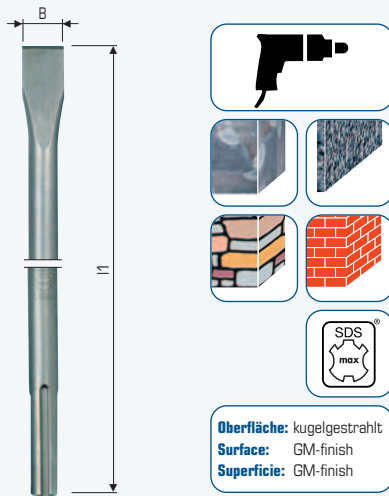

#### [RENDIMENTO] [ROBUSTO]

grazie al tratta-  
mento termico  
sottovuoto

grazie all'impiego  
di speciali acciai  
forgiati



SB-Aufhänger | Plastic tag  
Placchetta plastica

|  | l1<br>mm |         | Code 970<br>Art.-Nr. | Inh.<br>Cont. |  | €/Stk.<br>€/pc. |
|-------------------------------------------------------------------------------------|----------|---------|----------------------|---------------|-------------------------------------------------------------------------------------|-----------------|
| Spitz   Point   Punta                                                               | 280      |         | 00 970002801 00      | 1             | 1                                                                                   | 18,74           |
| Spitz   Point   Punta                                                               | 400      |         | 00 970004001 00      | 1             | 1                                                                                   | 21,45           |
| Spitz   Point   Punta                                                               | 600      |         | 00 970006001 00      | 1             | 1                                                                                   | 28,96           |
|  | l1<br>mm | B<br>mm | Code 971<br>Art.-Nr. | Inh.<br>Cont. |  | €/Stk.<br>€/pc. |
| Flach   Flat   Taglio piatto                                                        | 280      | 25      | 00 971002801 00      | 1             | 1                                                                                   | 18,74           |
| Flach   Flat   Taglio piatto                                                        | 400      | 25      | 00 971004001 00      | 1             | 1                                                                                   | 21,45           |
| Flach   Flat   Taglio piatto                                                        | 600      | 25      | 00 971006001 00      | 1             | 1                                                                                   | 29,26           |
|  | l1<br>mm | B<br>mm | Code 978<br>Art.-Nr. | Inh.<br>Cont. |  | €/Stk.<br>€/pc. |
| Breit   Wide   Taglio largo                                                         | 400      | 50      | 00 978005401 00      | 1             | 1                                                                                   | 31,65           |
| Breit   Wide   Taglio largo                                                         | 300      | 80      | 00 978008301 00      | 1             | 1                                                                                   | 40,96           |
| Breit   Wide   Taglio largo                                                         | 350      | 115     | 00 978011351 00      | 1             | 1                                                                                   | 97,62           |
|  | l1<br>mm | B<br>mm | Code 979<br>Art.-Nr. | Inh.<br>Cont. |  | €/Stk.<br>€/pc. |
| Breit gekröpft   Wide, cranked  <br>Taglio largo angolo inverso                     | 400      | 50      | 00 979005301 00      | 1             | 1                                                                                   | 36,56           |
| Breit gekröpft   Wide, cranked  <br>Taglio largo angolo inverso                     | 300      | 75      | 00 979008301 00      | 1             | 1                                                                                   | 46,82           |

Fortsetzung auf Seite VIII/17 | Continued on page VIII/17 | Segue a pagina VIII/17







>> SDS-MAX MEISSEL

SDS-MAX CHISEL

SCALPELLI SDS-MAX

Fortsetzung von Seite VIII/16 | Continued from page VIII/16 | Segue da pagina VIII/16

SB-Aufhänger | Plastic tag  
Placchetta plastica

|  | l1<br>mm | B<br>mm | Code 974<br>Art.-Nr. | Inh.<br>Cont. |  | €/Stk.<br>€/pc. |
|-----------------------------------------------------------------------------------|----------|---------|----------------------|---------------|-----------------------------------------------------------------------------------|-----------------|
| Hohl   Gouge   Sgorbia                                                            | 300      | 26      | 00 974026301 00      | 1             | 1                                                                                 | <b>37,12</b>    |
|  | l1<br>mm | B<br>mm | Code 972<br>Art.-Nr. | Inh.<br>Cont. |  | €/Stk.<br>€/pc. |
| Flügel   Winged gouge   Alette                                                    | 380      | 35      | 00 972003501 00      | 1             | 1                                                                                 | <b>137,92</b>   |



## >> AUFNAHMEADAPTER

### Einsatzbereich:

SDS-plus Kupplung mit SDS-max Aufnahme.  
Für alle Bohrhämmer mit SDS-max Aufnahme.

## SHANK ADAPTOR

### Range of application:

Converts SDS-max to SDS-plus. For all hammer drills with SDS-max shank.

## ADATTATORI

### Impiego:

Innesto SDS-plus con attacco SDS-max. Per tutti i martelli pneumatici con attacco SDS-max.

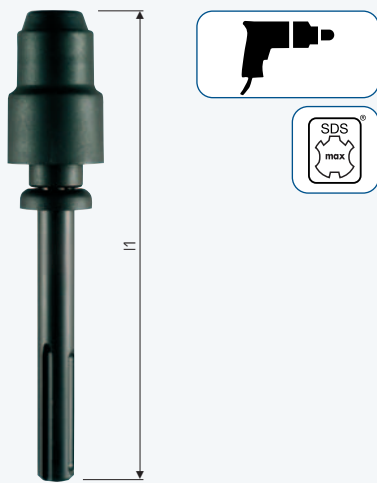

SB-Aufhänger | Plastic tag  
Placchetta plastica

| Aufnahmeadapter<br>Shank adaptor   Adattatori | l1<br>mm | Code 996<br>Art.-Nr. | Inh.<br>Cont. | €/Stk.<br>€/pc. |
|-----------------------------------------------|----------|----------------------|---------------|-----------------|
| SDS-max >> SDS-plus                           | 223      | 00 996000211 00      | 1             | <b>92,52</b>    |

## >> DREHZAHLN

Bitte beachten Sie die Drehzahlempfehlungen des jeweiligen Bohrhammer-Maschinenherstellers.

## SPINDLE SPEEDS

Please note the spindle speed of the respective hammer drilling machine recommended by the manufacturer.

## VELOCITÀ DI TAGLIO

Pregiamo prendere nota del nr di giri consigliati dai rispettivi fabbricanti delle macchine perforatrici.